

EZ ELECTRIC POWER STEERING INSTALLATION GUIDE

JAGUAR E-TYPE SERIES I (1961-1968)

JAGUAR E-TYPE SERIES II (1969-1971)

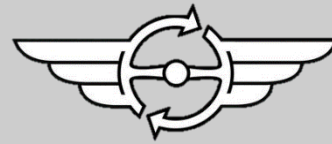



CONTENTS

1. THE PRODUCT _____	3
2. OVERVIEW OF THE KIT _____	4
3. INSTALLATION _____	5

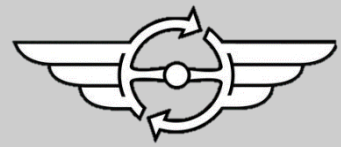

THE PRODUCT

Thank you for choosing an EZ ELECTRIC POWER STEERING product for its quality, its performance, type approval and its straightforward assembly. Since 2006 we have been manufacturing complete steering columns with integrated electrical assistance. All columns are tailor made for each type of car and we have over 200 different types in stock. For more information about our products (power steering systems and replica steering wheels) or to place an order, visit our website www.ezpowersteering.com or send an e-mail to info@ezpowersteering.nl. If you have any questions of a technical nature please contact workshop@ezpowersteering.nl.

Version C1.1

Date 24-01-2022

This manual should be read carefully to avoid errors. Check whether all parts of the set are present. This can be done on the basis of the picture in this manual. Before installation, compare the EZ POWER STEERING column with the original column. Check that the dimensions are the same. Also fit the steering wheel to the column.

If you do not have the skills or tools to perform the installation, have it performed by a professional. EZ POWER STEERING cannot be held liable for incorrect installation or self-inflicted damage.

The manuals are generally based on a left-hand-drive vehicle. In most cases, the right-hand drive version is the mirror image of the installation of a left-hand drive vehicle.

If you think that any changes are needed in this manual, we would like to receive your pictures and comments. With your feedback we can improve our manuals!

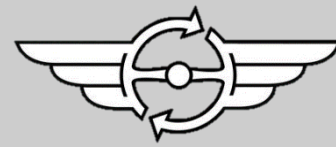

OVERVIEW OF THE KIT

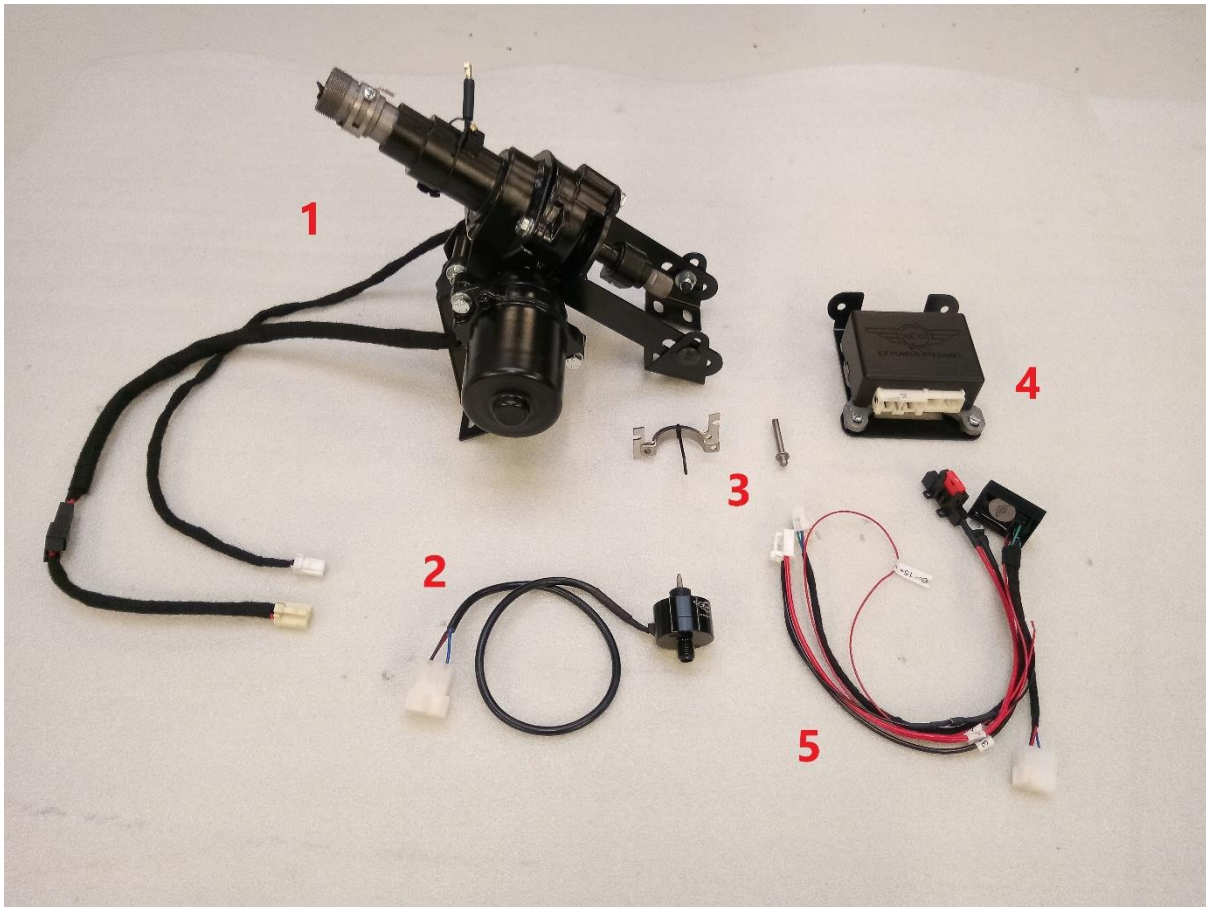

1. EZ unit
2. Speed sensor
3. Indicator bracket + horn pin (series 1 only)
4. ECU
5. EZ wiring harness + controller

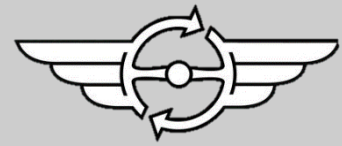

GENERAL INFORMATION

When installing the EZ Electric Power Steering unit (EZ-unit) column ensure that everything is precisely aligned so no oscillating shafts or shafts that are mounted with too much tension. Both items can worsen the self-centering effect of the steering.

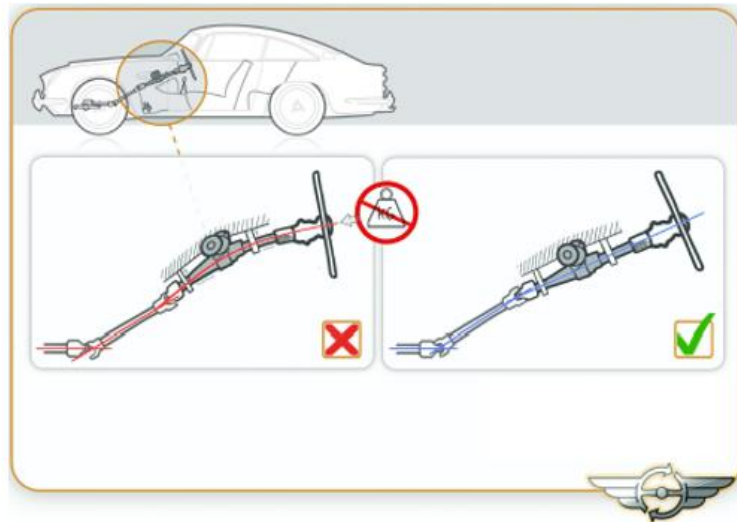

It's very important that the input shaft is **NEVER** hit with a hammer or being put under a load (radial/axial) while fitting, this will change the torque sensor settings and will cause the steering to be heavier to one side, or the unit will not work at all!

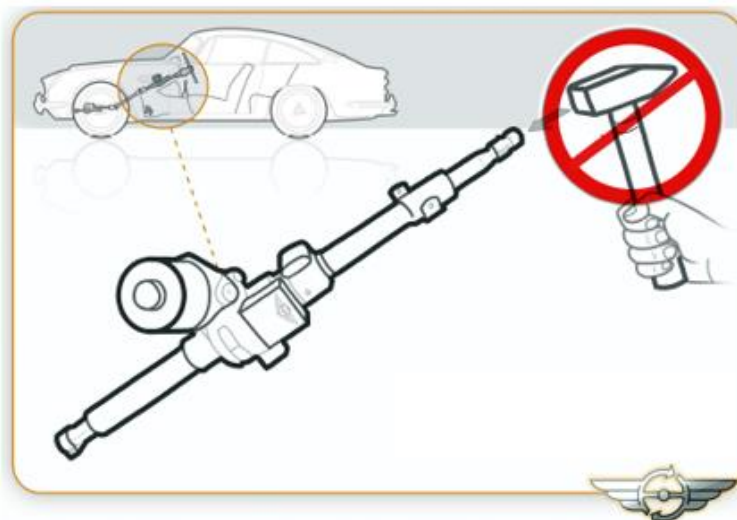

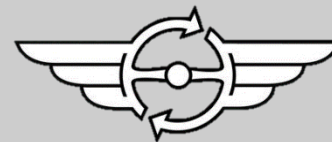

Check length, diameter and splines

Compare the EZ Power Steering Column (EZ-unit) with the original steering column before installing it. Check if the splines on the top and bottom, the diameter of the steering tube and the length of the column are all the same as the original steering column. When in doubt you can use the original steering wheel to check the top splines for fit.

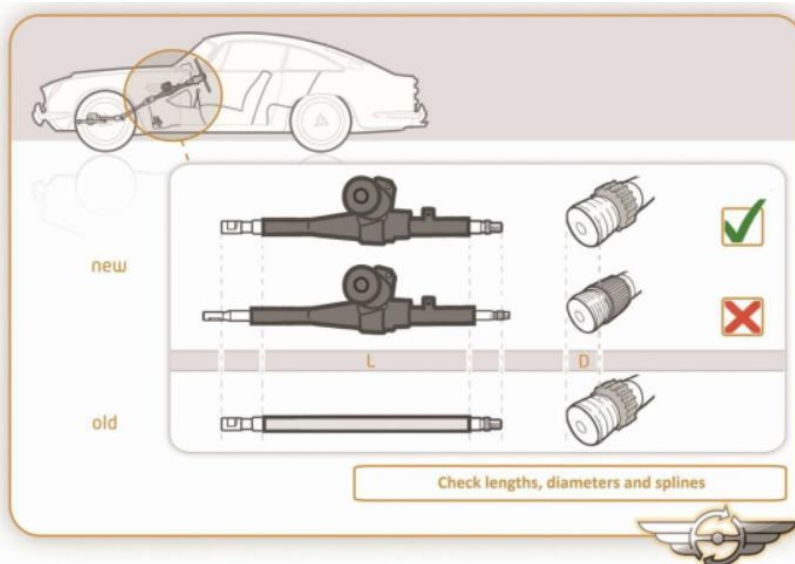

In the car industry it's common to have some small tolerances in spline connections. In very exceptional cases connecting a new shaft from the EZ-unit in the original (old) U-joint could cause a tight fitting. This is sometimes relatively easy to solve by sanding only about 0,2mm (0,007 inch) in the inner part of the U-joint and also the spline on the output shaft on the EZ-unit.



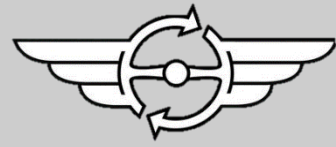

When the new steering column is being fitted hand tighten all the bolts and check if everything turns smoothly before tightening to required Torque, use torque tightening table below:

Torque tightening values in Nm.

	Alu	8.8	10.9	12.9
M6	6	11	16	19
M8	15	27	40	47

The system works with a torsion bar into the unit, this measures the amount of torque/load on the steering shaft while steering, the torque sensor measures this and sends a voltage to the ECU. The ECU uses this signal together with the speed signal to control the electric motor from the EZ-unit

Voltage

The basic EZ-unit, is a 12V system with negative earth! There are extra wiring sets available, so that the kit will work with a 6V or 24V system and/or positive earth. Check your vehicle setup before fitting the EZ-unit.

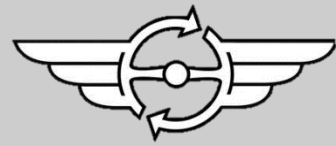

INSTALLATION

Step 1.

Check the following first before installation:

- The tyre pressure and test drive the car.
- The steering wheel returns to the straight-ahead position.
- If the steering and instruments show no defects.

If all above mentioned items are in order, proceed with the conversion.

Step 2.

Find a power supply switched via the ignition. This is necessary for activating the EZ powersteering unit. Then disconnect the battery negative earth cable.



Step 3.

Remove the locking screw, the horn push button and steering wheel.

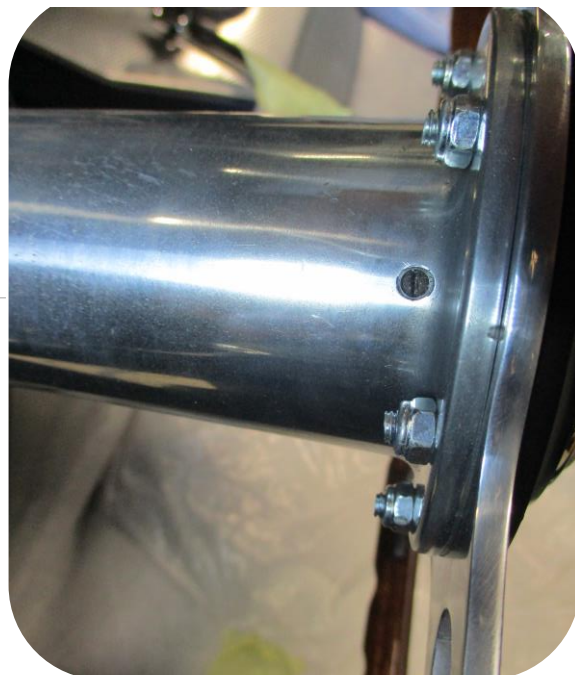

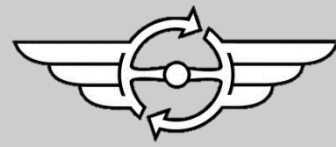

Step 4.

Remove both conical rings from the original steering shaft.



Step 5.

Remove the indicator switch from the original steering column.

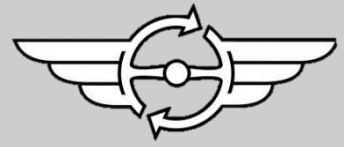

Step 6.

Remove the bolt from the indicator reset. The reset itself can be removed afterwards.

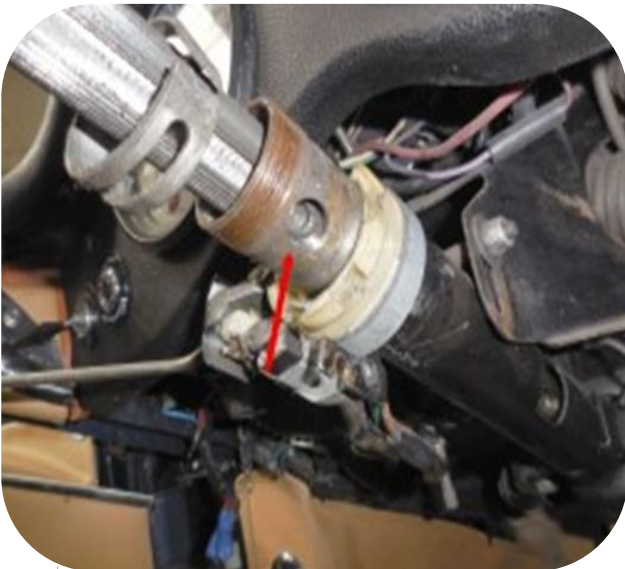

Step 7.

Remove the locking bolt from the steering shaft. The steering shaft itself can be removed afterwards.

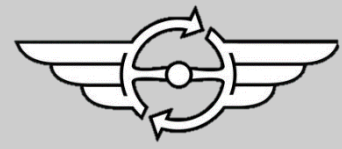

Step 8.

Make a note of the distance between the original steering shaft and the dashboard



Step 9.

Remove the bolt from the U-joint underneath the dashboard.

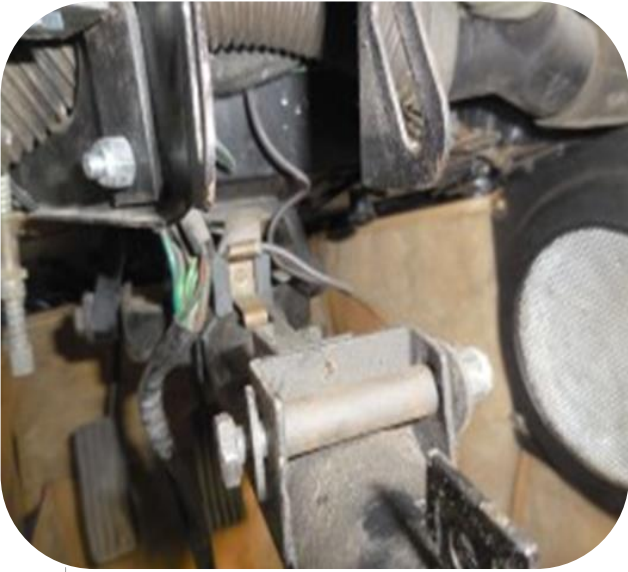
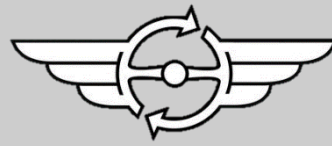

Step 10.

Remove the upper installation bolt from the original steering column.



Step 11.

Remove the lower installation bolts from the original steering column.

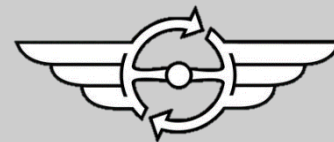

Step 12.

The original steering column can be removed from the vehicle.

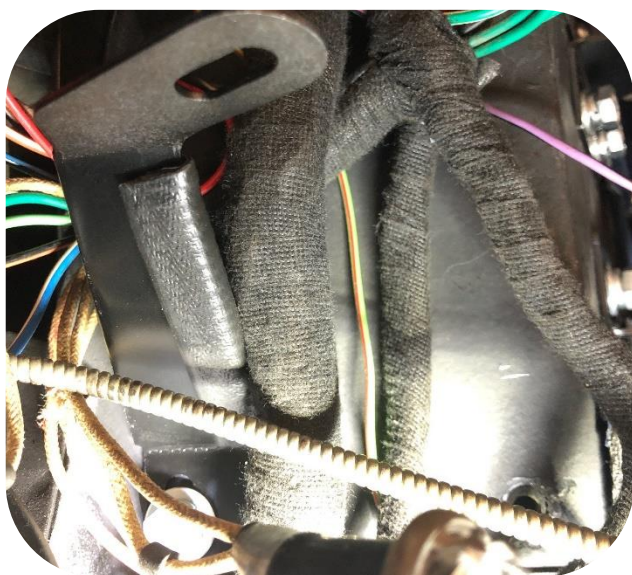

Step 13.

Install upper EZ bracket onto both original mounting points.

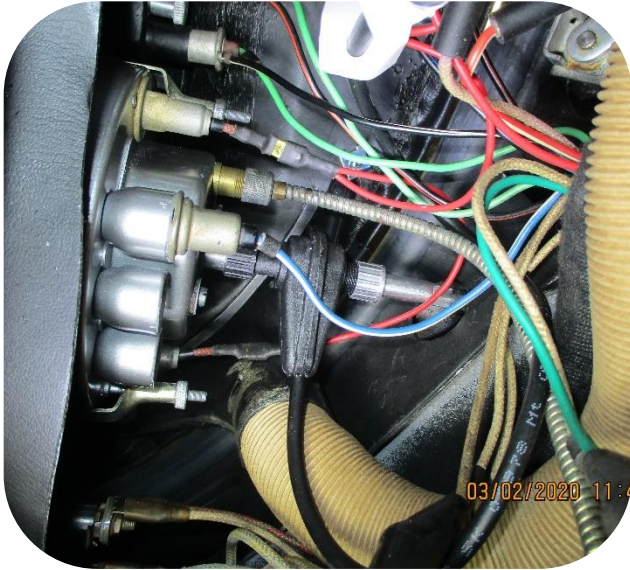
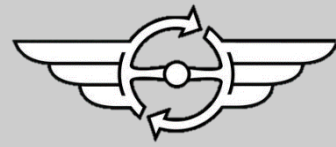

Step 14.

Install the speed sensor behind the speedometer. The cable can be fitted onto the sensor.



Step 15.

Install upper EZ bracket onto both original mounting points.

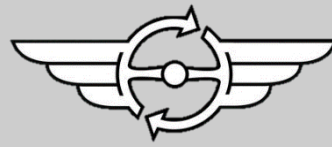

Step 16.

Mount the U-joint on the EZ unit and install the EZ unit in the car.



Step 17.

Check the distance between the dashboard and the steering shaft (see step 8) and adjust it if needed.

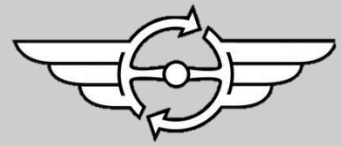

Step 18.

Once the EZ unit is in the right position, tighten all bolts of:

- The bracket
- Upper bracket
- Lower bracket
- U-joint



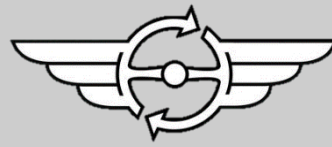

Step 19.

Mount the ECU on to the central console.

If mounting on the central console is not possible, an alternative is to mount the ECU in the bottom corners of the A-pillars.



Step 20.

Mount the indicator bracket.



Step 21.

Install the indicator switch.

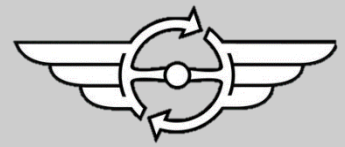

Step 22.

Mount locking screw back, do not tighten it.



Step 23.

Adjust the bracket of indicator switch.
Tighten the locking screw.
Check the function.



Step 24.

Install the cover of the indicator switch.



Step 25. (Series 1 only)

Install the contact pin for the horn button. The electric wire can be connected with the small hex screw. The original (plastic) holder and spring can be reassembled onto the new pin. Install this complete assembly onto the EZ unit.

Step 25 - Additional info

Series 1,5 - Install additional bracket for the ignition lock. Installation of the horn is depending if the car is based on series 1 of series 2.

Series 2 – Install the ignition/ steering lock. No bracket needed. The horn is on the indicator switch

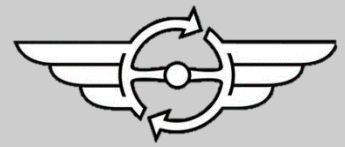

Step 26.

Connect the EZ harness with the ECU :

- Connect the thick red wire (30+) through the fuse holder, directly to the battery plus (12V)
- Connect the thin red cable (15+) to a positive terminal switch over the ignition. See Step 2.
- Connect the black ground wires (31) to a suitable ground point on the body.
- Connect the speed sensor to the EZ-unit wiring harness, make sure the wire colours in the connector correspond



Step 27.

Install both conical rings on the EZ unit.



Step 28.

Install the steering wheel assembly.

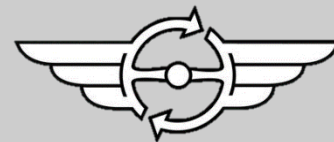

Step 29.

Connect the previously disconnected battery ground wire. After switching on the ignition a click can be heard from the ECU, the system is now operational, check this by making steering movements. After switching off the ignition a click is heard again after about 3 seconds. The system is now switched off.

Step 30.

Take a test drive and check all the systems again.